

Kit motore:

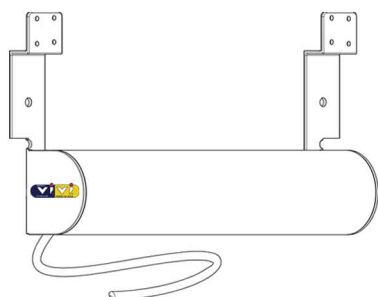

Staffa parete:

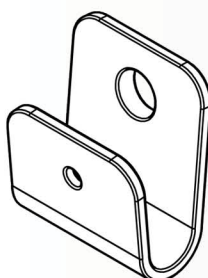

Staffa soffitto:

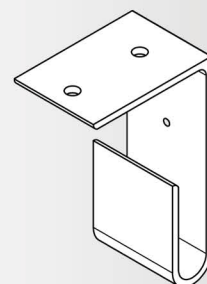

Dimensioni ed Ingombri:

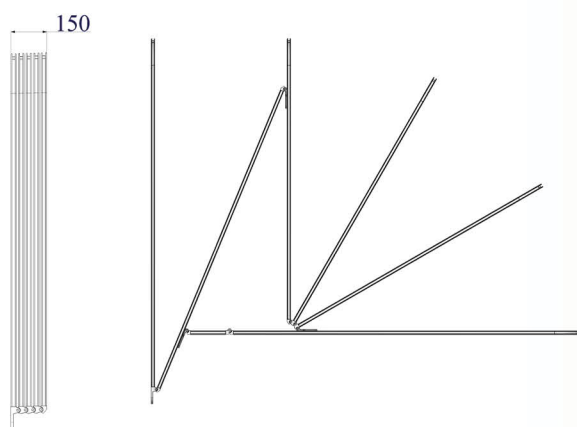

Ingombri profilo:

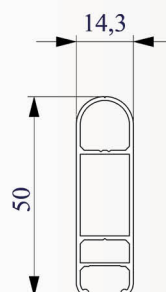

Kit arganello:

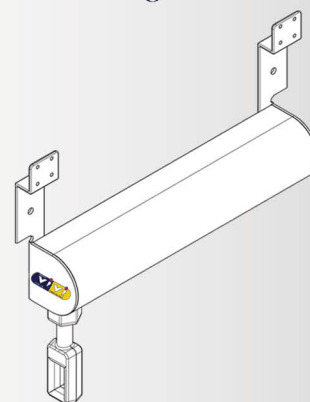

Descrizione Prodotto 5 Raggiere Allungata Raggiata:

Tenda a cappottina con curve e cerniere in alluminio. Profilo in alluminio estruso da mm. 14,3 x 50,0.
 Apertura e chiusura con fune.

Vista laterale dello Scheletro Quotato:

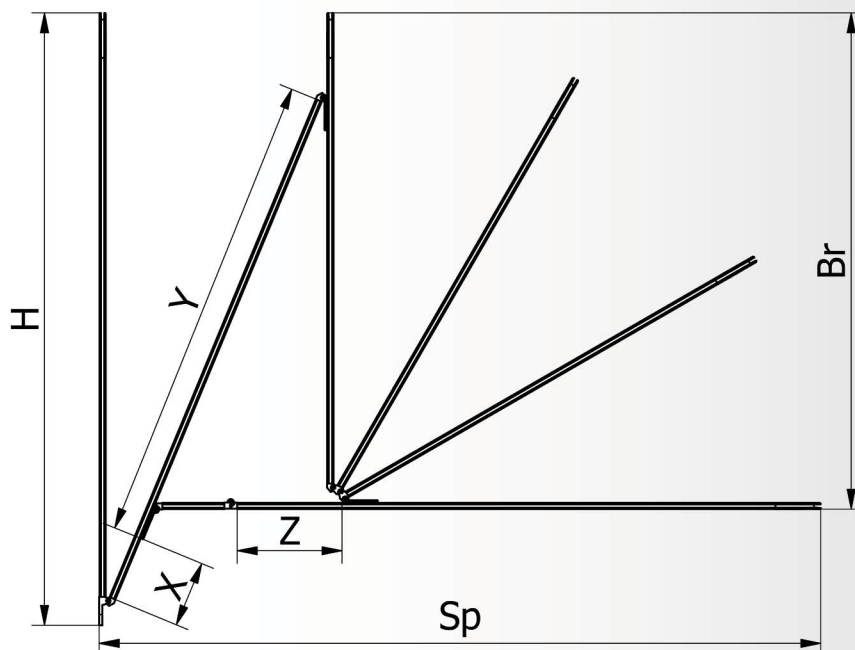

Esploso:

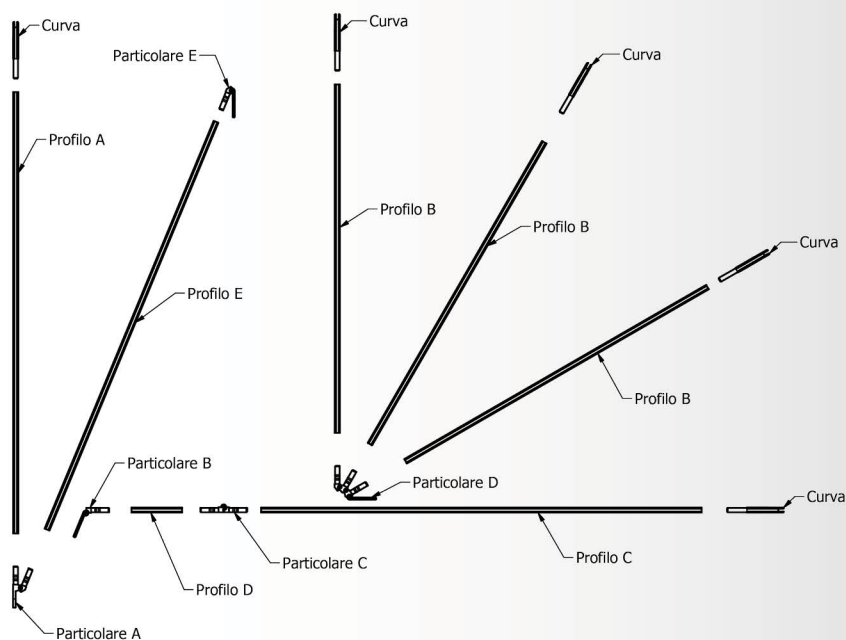

Costruzione Cappottina 5 Raggere Allungata (misure in centimetri)										
Sp	Br	Pr A	Pr B	Pr C	Pr D	Pr E	x	y	z	H
90	50	89,5	27,5	31,5	9,3	91,5	57	34,5	7	102,5
90	60	57	36	45,2	9	56	12	44	12	70
100	60	85,5	29	39,5	10	87	47	40	13	98,5
100	80	72	63	67,5	8	73	5	68	7	85
110	70	98,5	44,8	56	11	99,5	47	52,5	15	111,5
110	80	91	61	69	9	92,5	25	67,5	11	104
120	80	88	50	68,5	12	87,2	24,5	62,7	21,5	101
120	70	112	37,5	47,5	13	113,5	65	48,5	13	125
125	100	108	82,7	88,5	8	108,7	21,2	87,5	9	121
130	80	133	53,5	65,5	10	133	72,5	60,5	15	146
130	100	109	79,5	90,2	10	107,5	23,5	84	13,7	122
140	85	124	38,5	60,5	11	123,5	67,5	56	25	137
140	90	127	56,7	76	11,5	128,3	59,3	69	22	140
140	100	126	77,5	91,2	11,5	126,5	41	85,5	16,8	139
150	110	115	84,2	104,3	14	115	21	94	22,5	128
160	100	147,3	64	86,5	14	148	70	78	25,2	160,3
180	110	163,5	75,7	103	16	164	72,5	91,5	30	176,5